

# System Test Booklet



HP 9825 Desktop Computer

Hewlett-Packard Desktop Computer Division  
3404 East Harmony Road, Fort Collins, Colorado 80525

Copyright by Hewlett-Packard Company 1978

**CAUTION**

The HP9825 Computer can be severely damaged if it has not been set to the correct voltage; if in doubt, please refer to the Operating and Programming Reference.

# Table of Contents

General Information	
Introduction .....	1
Calculator Tests	
Procedure .....	3
Test Descriptions .....	5
Test Modifications .....	11
Peripheral Tests	
Introduction .....	13
Rom Error Messages .....	15
2631A Printer .....	16
9862A Plotter .....	21
9863A Tape Reader .....	25
9864A Digitizer .....	28
9866A/B Thermal Printer .....	32
9869A Hopper Card Reader .....	36
9871A Impact Printer .....	39
9872A Plotter Dynamic Test .....	42
9881A Printer Test .....	45
9883A Paper Tape Photo Reader .....	56
9884A Paper Tape Punch .....	58
98032A 16-Bit Interface .....	61
98033A BCD Interface .....	64
98034A Interface .....	67
98035A Real Time Clock .....	71
98036A Serial Interface .....	74



# Chapter 1

## General Information

### Introduction

This booklet contains test procedures to verify the performance of the HP 9825 Computer system. The System Test Cartridge (Part No. 09825-90036) contains the necessary programs to implement these tests.

The tests are divided into two groups:

1. Calculator Tests
2. Peripheral Tests

The calculator should be thoroughly tested before attempting to test any of the peripherals.

This booklet assumes that the calculator will turn-on and display  $\frac{1}{1}$ . If not, refer to the Operating and Programming Manual for installation procedures, fuse requirements, and if necessary, the Sales and Service Offices locations.

The symbol  $\left(\begin{smallmatrix} \text{A} \\ \text{SHIFT} \end{smallmatrix}\right)$  is used in this booklet to indicate that the shift key should be held down while the next key is pressed. Example:

$$\left(\begin{smallmatrix} \text{A} \\ \text{SHIFT} \end{smallmatrix}\right) = a$$
$$\left(\begin{smallmatrix} \text{A} \\ \text{SHIFT} \end{smallmatrix}\right) = A$$



# Chapter 2

## Calculator Tests

### Procedure

To Test the Calculator

1. Turn the calculator ON.
2. The following display should be seen.



3. Insert the Test Cartridge so that the label on the cartridge faces the back of the calculator.
4. Press:

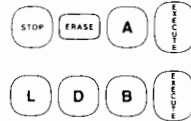

5. The following display should be seen.



The symbol  $\left(\begin{smallmatrix} \text{A} \\ \text{I} \end{smallmatrix}\right)$  is used in this booklet to indicate that the shift key should be held down while the next key is pressed. Example:

$$\text{A} = a$$

$$\left(\begin{smallmatrix} \text{A} \\ \text{I} \end{smallmatrix}\right) \text{A} = A$$

#### 4 Calculator Tests

6. The following tests are available on the Test Cartridge:

- 1 R/W Memory Test
- 2 ROM Test
- 3 Processor Test
- 4 Tape Cartridge Test
- 5 Printer Test
- 6 Display Test
- 7 Key Switch Test
- 0 Abort (clears the calculator)

Run each of these tests by typing-in the test number followed by **CONTINUE**. Refer to the next sections of this booklet for detailed information about each test.

At the end of each test the following display will be seen:

WHICH TEST(S)?

type-in the next test number followed by **CONTINUE**.

If the wrong key is pressed while typing the test number press **STOP** **CONTINUE** and then type the correct test number.

If errors are printed or if the results are not as described for the tests, press:

**RESET** **R** **T** **B** \* **CONTINUE**

and then repeat the test. If there are still errors, contact the nearest HP Sales and Service Office for assistance; office locations are listed at the back of the 9825 Operating and Programming Reference.

\*rtb = return to binary



# Test Descriptions

1 R/W Memory Test

The following display and printout should be seen.

```

R/W MEMORY TEST
20 to 80 seconds

R/W MEMORY TEST
60K BOARD PASSED } This information will vary
70K BOARD PASSED } depending on the memory
50K BOARD PASSED } options installed (see table below).

R/W MEMORY TEST
COMPLETE
    
```

Memory Location	9825A	9825S	9825B	9825T
70k	Std.	Std.	Std.	Std.
60k	Opt. 001	Std.	Std.	Std.
50k	Opt. 002	Std.	Std.	Std.
40k	Opt. 003	Std.*	Std.*	Std.
30k	n/a	n/a	n/a	Std.
20k	n/a	n/a	n/a	Std.
10k	n/a	n/a	n/a	Std.
02k	n/a	n/a	n/a	Std.

\* This memory location is enabled by jumper.

If there are no errors printed the R/W Memory is operating properly.

6 Calculator Tests

2 ROM Test

The following display and printout should be seen.

```
ROM TEST
```

5 seconds

```
ROM TEST
```

```
ROMS ON SYSTEM:
```

```
MAINFRAME
```

```
32 K  
34 K  
40 K  
46 K
```

} This information will vary depending on the ROM(s) installed (see table below).

```
ROMS IN ERROR:
```

```
NONE
```

} Errors will be printed here.

```
ROM TEST  
COMPLETE
```

ROM Numbers and Titles

ROM Location	9825A/S	9825B/T
30k Flex. Disc	Opt.	Opt.
32k Gen'l. I/O	Opt.	Std.
34k Plotter	Opt.	Std.
36k Matrix	Opt.	Opt.
36k Sys. Prog.	Opt.	Std. (w/T only)
40k Adv. Prog.	Opt.	Std.
42k Ext. I/O	Opt.	Std.
44k Ext. I/O	Opt.	Std.
46k Strings	Opt.	Std.
50k Sys. Prog	n/a	Std. (w/T only)

If NONE is printed for errors the ROM(s) are operating properly.

**3** Processor Test

The following printout should be seen.

```
PROCESSOR TEST  
PROCESSOR PASSED
```

If there are no errors printed the processor is operating properly.

**4** Tape Cartridge Test

The following display and printout should be seen.

```
INSERT SCRATCH CARTRIDGE
```

```
CARTRIDGE TEST
```

Remove the Test Cartridge and insert a scratch cartridge\*, then press **CONTINUE**.

After about 45 seconds the following display and printout should be seen.

```
REPLACE TEST CARTRIDGE
```

```
CARTRIDGE TEST  
COMPLETE
```

Remove the scratch cartridge, re-insert the Test Cartridge, and then press **CONTINUE**.

\*The scratch cartridge must be a known-good, unprotected tape cartridge which does not contain wanted information.

8 Calculator Tests

5 Printer Test

The following display and printout should be seen during the printer test.

```
PRINTER TEST
```

5 seconds

```
PRINTER TEST
```

```
=====  
=====  
=====
```

```
◀◊×Nα@ΓπΔσ↓λν←r‡  
0QδAáÁäÖö00Ee²£¤  
!"#$%&'()*+,-./  
0123456789:; <=>?  
@ABCDEFGHIJKLMNO  
PQRSTUVWXYZ [r] ↑_   
'abcdefghijklmno  
parstuvwxyz{|}~Σ†
```

```
PRINTER TEST  
COMPLETE
```

The printout should duplicate the above sample.

6 Display Test

The following printouts and displays should be seen. Each display should be checked for missing or extra display dots.

DISPLAY TEST

5 seconds, this display may flicker

3 seconds

3 seconds

20 seconds

20 seconds

20 seconds

20 seconds

DISPLAY TEST  
COMPLETE

Pressing:

- will stop the display test, to allow more viewing time.
- again, will continue the display test.
- will abort the display test.

7 Key Switch Test

The following display and printout should be seen.

PRESS PRT ALL

KEYBOARD TEST

Check the keys for proper operation by pressing each key as it is called for by the display. Remember to press **SHIFT** before pressing **A**. Leave shift key locked until display reads

PRESS Z

Press **SHIFT** (to unlock shift) before pressing **Z**.

The key sequence called for by the display is shown below.

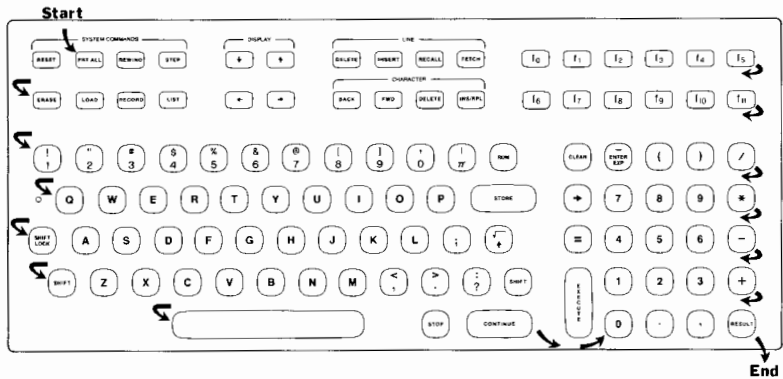

An error message will be printed if:



- the wrong keys are pressed four times in succession.
- the correct key fails to operate properly.

If a key completely fails to operate, press any other key four times to continue the test.

After the last key (RESULT) is pressed the following printout should be seen.

KEYBOARD TEST  
COMPLETE

 Abort

Pressing   will abort the Calculator Test and return the calculator to normal operation.

## Test Modifications

A group of tests can be run in succession by typing-in more than one test number before pressing . The tests will run in numerical order regardless of the order in which they are typed.

Examples:

3412

runs tests: 1, 2, 3, and 4

76123

runs tests: 1, 2, 3, 6, and 7





# Chapter **3**

## Peripheral Tests

### Introduction

Tests for the 9800 series peripherals are available on the test cartridge. The peripheral tests that are available and the ROMs required for each test are listed in Table 1. Sample ROM printout messages are included following Table 1.

1. Ensure that the proper plug-in option ROM(s) are installed in the computer (see Table 1) and that the peripheral device is properly connected to the computer. Connection instructions for each peripheral device are included with the test instructions for that particular device.

---

**WARNING**

POWER TO THE 9825 AND PERIPHERALS  
MUST BE TURNED OFF BEFORE INSERTING  
OR REMOVING INTERFACES OR PLUG-IN  
ROMS. FAILURE TO DO SO MAY CAUSE  
DAMAGE TO THE INTERFACES, ROMS, OR  
TO THE COMPUTER.

---

2. Proceed to the appropriate instructions for the device that is being tested. These sections follow.

## 14 Peripheral Tests

If errors are printed or if the results are not as described for the test, ensure that the Test Cartridge is installed and then press **STOP** **BACK**. Repeat the test. If there are still errors, contact the nearest HP Sales and Service Office for assistance; office locations are listed at the back of the 9825 Operating and Programming Reference.

Table 1

		General I/O	Extended I/O	9862A Plotter	9872A Plotter
2631A	Dot-Matrix Printer	x	1		
+9862A	Plotter	x		x	
9863A	Paper Tape Reader	x			
9864A	Digitizer	x			
9866A/B	Thermal Line Printer	x			
9869A	Hopper Card Reader	x			
9871A	Impact Printer	x			
9872A	4 Color Plotter Dynamic	x			x
9881A	Impact Printer Test	x			
9883A	Paper Tape Photo Reader	x			
9884A	Paper Tape Punch	x			
98032A	16-Bit Interface	x			
98033A	BCD Interface	x			
●98034A	HP-IB (IEEE-488) Interface	x	x		
98035A	Real Time Clock Interface	x	1		
98036A	Serial Data Interface	x	1		

+ This test will work with the 9872A if the 9872A Plotter ROM is installed.

1 These tests will be more extensive when the Extended I/O ROM is also installed.

● This test requires two 98034A cards – one card tests the other.

## ROM Error Messages

```
*****
* BAD ROM(S) *
*           *
* GENERAL I/O *
*           *
*****
```

In this example, the General I/O ROM (part of 98214A ROM) was determined to be defective by the program.

```
PLEASE VERIFY
THE FOLLOWING:

GEN. I/O ROM IN
EXT. I/O ROM OUT
9862A ROM IN
9872A ROM OUT
```

It is important to check the ROM listing carefully. In this case the Extended I/O ROM was listed as being out when it was actually plugged in. This indicates that the Extended I/O ROM is defective.

```
TESTS REQUIRE
GEN. I/O ROM
TO OPERATE

PLEASE TURN UNIT
OFF, INSERT
GEN. I/O ROM
AND RESTART TEST
```

All peripheral tests require the General I/O ROM. If it is not plugged in or if it is defective, this message is printed.

## 2631A Printer

This test requires the General I/O ROM. The test is more extensive with the Extended I/O ROM also installed.

1. Assure that calculator and printer power are turned OFF.
2. Install the General I/O ROM (and possibly the Extended I/O ROM) and connect the printer interface to the printer and to the calculator.
3. Check the select code of the interface and the Bus Address of the Binary Address switches located on the right rear of the printer.

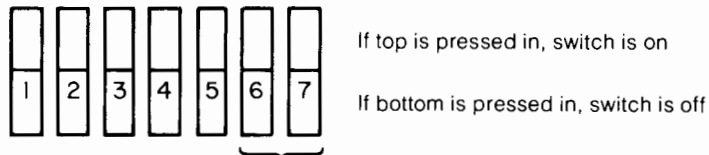

These two switches always off for the test.

Switch #	Binary Value	
1	16	
2	8	
3	4	
4	2	
5	1	
6	Listen Always	(should be off)
7	SRQ	(should be off)

Example:

If switches #1 and 3 were on and the others were off, the printer address would be 20.

4. Set the printer slide switches (located under printer front cover) for print mode and line spacing as follows:

Line Spacing – 8LPI

Print Mode – Norm

5. Load the printer with standard 11" x 14 $\frac{7}{8}$ " paper (see 2631A Printer Installation and Service Manual) and turn calculator and printer power ON. Depress printer RESET key and OFF-LINE, ON-LINE switch to initialize it and put it on line. Printer power-on light, 8-LPI light, and on-line light should glow.
6. With the test cartridge in your calculator, press:

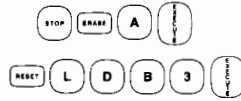

7. The tape should load and the calculator should print a message similar to the one below, depending on which ROM(s) are installed.

<pre>PLEASE VERIFY   THE FOLLOWING: GEN. I/O ROM IN EXT. I/O ROM OUT 9862A   ROM IN 9872A   ROM OUT</pre>	<p>This information will vary depending on ROM(s) that are installed. Other ROM(s) such as Matrix, String, and Systems Programming are not included in listing.</p>
---	---

After the ROM verify printout, the display should return with:

ENTER MODEL # TO BE TESTED... .

Press: 2 6 3 1 A CONTINUE

8. When the display returns with:

ENTER SELECT CODE... .

Enter the select code of the interface followed by the printer Bus Address (see step 3) for example, if the interface select code is 7 and printer address is 05, then

press: 7 0 5 CONTINUE

9. The printer should print the following patterns.



Z31A EXERCISES ON 9825A CALCULATOR  
SINGLE SPACE VFC SLEW  
SINGLE SPACE VFC SLEW  
DOUBLE SPACE VFC SLEW  
DOUBLE SPACE VFC SLEW  
TRIPLE SPACE VFC SLEW

QUARTER PAGE VFC SLEW  
1 LINE PER INCH \*\*\*\*

2 LINES PER INCH \*\*\*\*

2 LINES PER INCH \*\*\*\*

3 LINES PER INCH \*\*\*\*

3 LINES PER INCH \*\*\*\*

3 LINES PER INCH \*\*\*\*

4 LINES PER INCH \*\*\*\*

4 LINES PER INCH \*\*\*\*

4 LINES PER INCH \*\*\*\*

4 LINES PER INCH \*\*\*\*

6 LINES PER INCH \*\*\*\*

6 LINES PER INCH \*\*\*\*

6 LINES PER INCH \*\*\*\*

6 LINES PER INCH \*\*\*\*

8 LINES PER INCH \*\*\*\*

8 LINES PER INCH \*\*\*\*

8 LINES PER INCH \*\*\*\*

8 LINES PER INCH \*\*\*\*

8 LINES PER INCH \*\*\*\*

8 LINES PER INCH \*\*\*\*

8 LINES PER INCH \*\*\*\*

8 LINES PER INCH \*\*\*\*

8 LINES PER INCH \*\*\*\*

8 LINES PER INCH \*\*\*\*

8 LINES PER INCH \*\*\*\*

8 LINES PER INCH \*\*\*\*

8 LINES PER INCH \*\*\*\*

8 LINES PER INCH \*\*\*\*

8 LINES PER INCH \*\*\*\*

8 LINES PER INCH \*\*\*\*

8 LINES PER INCH \*\*\*\*

8 LINES PER INCH \*\*\*\*

8 LINES PER INCH \*\*\*\*

8 LINES PER INCH \*\*\*\*

8 LINES PER INCH \*\*\*\*

8 LINES PER INCH \*\*\*\*

8 LINES PER INCH \*\*\*\*

8 LINES PER INCH \*\*\*\*

8 LINES PER INCH \*\*\*\*

8 LINES PER INCH \*\*\*\*

8 LINES PER INCH \*\*\*\*

8 LINES PER INCH \*\*\*\*

8 LINES PER INCH \*\*\*\*

8 LINES PER INCH \*\*\*\*

8 LINES PER INCH \*\*\*\*

8 LINES PER INCH \*\*\*\*

8 LINES PER INCH \*\*\*\*

8 LINES PER INCH \*\*\*\*

8 LINES PER INCH \*\*\*\*

8 LINES PER INCH \*\*\*\*

8 LINES PER INCH \*\*\*\*

8 LINES PER INCH \*\*\*\*

8 LINES PER INCH \*\*\*\*

8 LINES PER INCH \*\*\*\*

8 LINES PER INCH \*\*\*\*

8 LINES PER INCH \*\*\*\*

8 LINES PER INCH \*\*\*\*

8 LINES PER INCH \*\*\*\*

8 LINES PER INCH \*\*\*\*

8 LINES PER INCH \*\*\*\*

8 LINES PER INCH \*\*\*\*

8 LINES PER INCH \*\*\*\*

8 LINES PER INCH \*\*\*\*

8 LINES PER INCH \*\*\*\*

8 LINES PER INCH \*\*\*\*

8 LINES PER INCH \*\*\*\*

8 LINES PER INCH \*\*\*\*

8 LINES PER INCH \*\*\*\*

8 LINES PER INCH \*\*\*\*

8 LINES PER INCH \*\*\*\*

8 LINES PER INCH \*\*\*\*

8 LINES PER INCH \*\*\*\*

8 LINES PER INCH \*\*\*\*

BOTTOM OF FORM

## 20 Peripheral Tests

10. If you wish to re-run the test, wait until the test is complete and the display reads

"TO RESTART PRESS CONTINUE"

and press .

11. If no errors appear on the calculator printout and the printer page matches patterns in step 9, then the printer is working properly.
12. If errors are printed or the printer page does not match the patterns in step 9, carefully repeat the test procedure. If errors still occur, contact the nearest HP Sales and Service Office; locations are listed in the back of the 9825 Operating and Programming Reference.



## 9862A Plotter

### To Test the Plotter

1. Install the 9862A Plotter ROM and General I/O ROM in the calculator. The 9872A Plotter ROM must NOT be installed.
2. Switch the plotter and calculator ON. The LINE indicator on the plotter should light.
3. On the Plotter:
  - a. Place a sheet of plotter paper (P/N 9270-1004 supplied with the plotter) on the platen and align the paper against the bottom and left-edge paper guides. Press CHART HOLD and smooth the paper on the platen.
  - b. Adjust the LOWER LEFT Graph Limit controls to align the pen exactly over the lower left corner of the grid on the paper. Then adjust the UPPER RIGHT Graph Limit controls to align the pen over the upper-right corner of the grid.\*
4. With the test cartridge in your calculator, press:

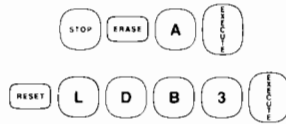

5. The tape should load and the printer should print a message similar to the one below, depending on which ROM(s) are installed in the calculator.

PLEASE VERIFY  
THE FOLLOWING:

```

GEN. I/O ROM IN
EXT. I/O ROM IN
9862A   ROM IN
9872A   ROM OUT
  
```

This information will vary depending on ROM(s) that are installed. Other ROM(s) such as Matrix, String, and Systems Programming are not included in listing.

\*This procedure must be completed very carefully, as the accuracy of the plot depends on it.

## 22 Peripheral Tests

After the ROM verify printout, the display should return with:

ENTER MODEL # TO BE TESTED...

press

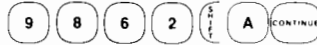

6. When the display returns with:

ENTER SELECT CODE...

enter the select code and press **CONTINUE**. To specify the factory set select code just press **CONTINUE**.

7. When the display returns with:

WHICH TEST? RETRADE=0 DYNAMIC=1

enter either 0 or 1 depending on the test you want to run (refer to steps 10 and 11).

8. When the display returns with:

ENTER # OF TIMES TO RUN TEST...

enter the number of times you want the test to run and press **CONTINUE**.

9. When the display returns with:

LOAD PAPER, PRESS CONTINUE

ensure that the plotter is loaded with paper as described in step 3 and that the pen is ready. Press **CONTINUE**.

**Retrace Plot**

10. The retrace plot should duplicate the sample plot shown in this figure.

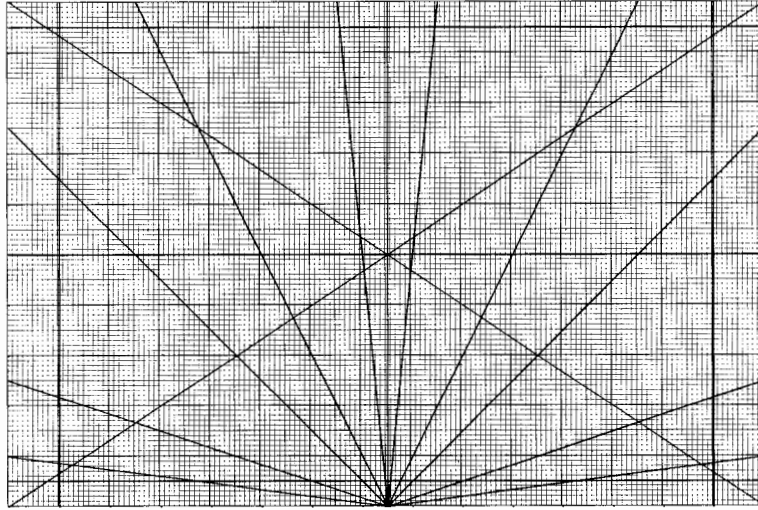

Plotter alignment can be verified by comparing the plot with the following specifications:

- a. Alignment Verification - all vertical and horizontal lines (6) align within 0.010 inch of preprinted grid.
- b. Retrace Verification - all retraced lines (11) radiating from bottom center) are open less than 0.015 inch.
- c. Servo Matching Verification - the single horizontal trace (at bottom of Plot) has inflections less than 0.015 inch in amplitude.
- d. All angular lines bow no more than 0.040 inch from the true straight line between end points.

Dynamic Plot

- The dynamic plot should duplicate the sample plot shown in this figure.

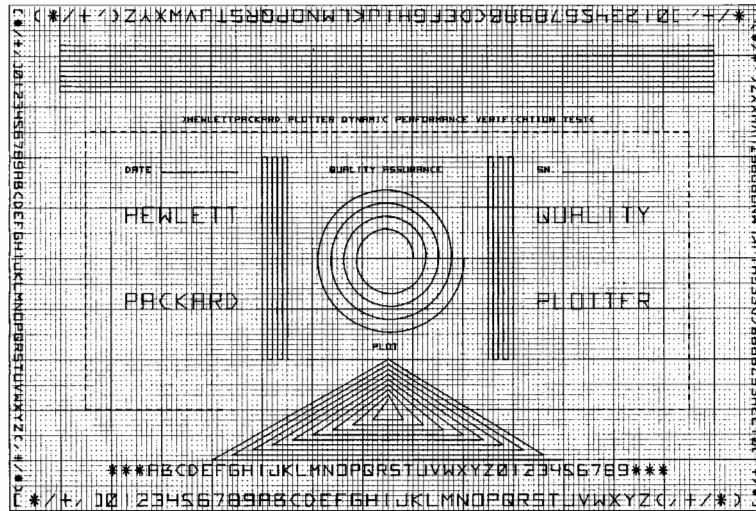

- If the plotter fails to duplicate the sample plots, verify that the paper is properly positioned and that the lower-left and upper-right corners are properly aligned; then repeat the procedure. If the sample plot cannot be duplicated, contact the nearest HP Sales and Service Office for assistance; office locations are listed at the back of the 9825 Operating and Programming Reference.

# 9863A Tape Reader

This test requires the General I/O ROM.

To Test the Tape Reader

1. Make sure that the calculator and tape reader are properly connected.
2. Switch the calculator and the tape reader ON.
3. Set the program board on the tape reader as shown:

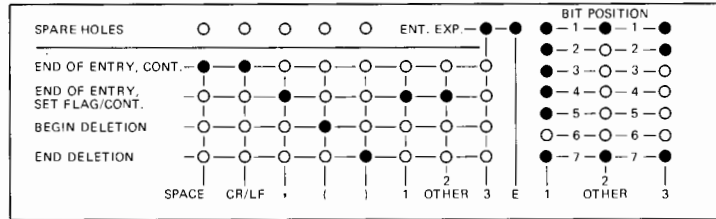

4. Set the Mode Switch to Data, and set the Selector switch to STOP.
5. Load the last section of the diagnostic tape (09863-90002) supplied with the tape reader and set the Selector switch to START.
6. With the test cartridge in your calculator, press:

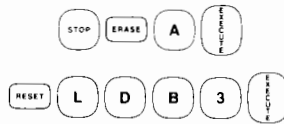

7. The tape should load and the printer should print a message similar to the one below, depending on which ROM(s) are installed in the calculator.

PLEASE VERIFY THE FOLLOWING:	This information will vary depending on ROM(s) that are installed. Other ROM(s) such as Matrix, String, and Systems Prog- ramming are not included in listing.
GEN. I/O ROM IN	
EXT. I/O ROM IN	
9862A ROM IN	
9872A ROM OUT	

After the ROM verify printout, the display should return with:

ENTER MODEL # TO BE TESTED...

press

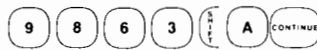

8. When the display returns with:

ENTER SELECT CODE...

enter the select code and press **CONTINUE**. To specify the factory set select code just press **CONTINUE**.

9. When the display returns with:

ENTER # OF TIMES TO RUN TEST...

enter the number of times you want the test to run and press **CONTINUE**.

10. When the display returns with:



LOAD TAPE, PRESS CONTINUE

ensure that the punched tape is loaded in the tape reader, and then press



11. The tape reader should read the entire tape and then print:

TEST COMPLETE

12. If the tape reader stops and the computer prints an error, carefully repeat the entire procedure. If the exercise still cannot be successfully run, the tape reader may be defective. For assistance, contact the nearest HP Sales and Service Office; locations are listed at the back of the 9825 Operating and Programming Reference.

## 9864A Digitizer

This test requires the General I/O ROM.

### To Test the Digitizer

1. Make sure that the calculator and digitizer are properly connected.
2. Switch the calculator and digitizer ON. You should hear a beep from the digitizer and the LINE switch should light.
3. With the test cartridge in your calculator, press:

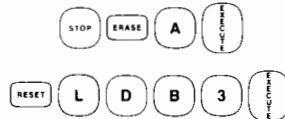

4. The tape should load and the printer should print a message similar to the one below, depending on which ROM(s) are installed in the calculator.

```
PLEASE VERIFY
THE FOLLOWING:
```

```
GEN. I/O ROM IN
EXT. I/O ROM IN
9862A ROM IN
9872A ROM OUT
```

This information will vary depending on ROM(s) that are installed. Other ROM(s) such as Matrix, String, and Systems Programming are not included in listing.

After the ROM verify printout, the display should return with:

```
ENTER MODEL # TO BE TESTED. . . .
```

press

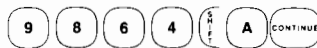



5. When the display returns with:

ENTER SELECT CODE . . .

enter the select code and press **CONTINUE**. To specify the factory set select code just press **CONTINUE**.

---

**NOTE**

From this point until the end of this procedure, move the cursor only as directed. When directed to move the cursor from one point to another, do so by sliding the cursor; do not lift the cursor from the digitizing surface unless specifically instructed to do so. Also, do not slide the cursor outside the digitizing area unless instructed to do so.

---

6. When the display returns with:

TURN 9864A OFF AND THEN ON

place the cursor near the middle of the platen and then turn the digitizer OFF and then ON. The digitizer should beep each time it is turned OFF or ON. Press **CONTINUE**.

7. When the display returns with:

LIFT CURSOR FROM 9864A PLATEN

lift the cursor from the platen, a beep should be heard. Return the cursor to the platen and press **CONTINUE**.

XY Test

8. The following display should be seen.

SET ORIGIN&TAKE SAMPLE AT POINT 1

Place the cursor over point 1 (refer the following figure) and press **O** (origin) and **S** (single sample) on the cursor.

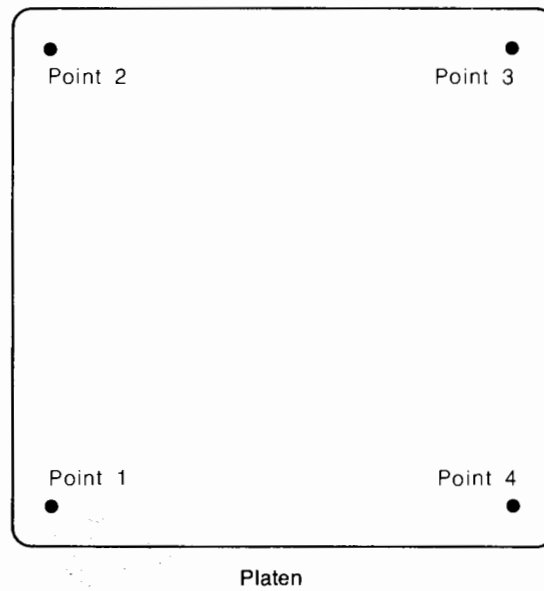

9. Press **S** at each of the other points as called for by the display.
10. If XY TEST COMPLETE is printed continue to the Hold Test. If ERROR is printed the XY TEST will be restarted, carefully repeat the procedure starting at step 8. If the XY Test continues to fail, refer to step 16.

**Hold Test**

11. Place the cursor over the lower-left dot (point 1), press **Q** and **C** (continuous sample) on the cursor.
12. Move the cursor to the upper-right dot (point 3) and press **H** (hold) on the cursor, once. Note the values of X and Y as they are displayed by the calculator.
13. Move the cursor to the lower-left dot and press **H** , once.
14. Repeat (about 5 more times) steps 12 and 13 until the displayed values for X and Y “roll over” from 99.99 to 0.00; it is not necessary to see the actual change.
15. When the X and Y values have rolled over the tests are complete. If there have been no failures the digitizer is operating properly. If there have been failures carefully repeat the tests.
16. If there are still failures contact the nearest HP Sales and Service Office; locations are listed at the back of the 9825 Operating and Programming Reference.

## 9866A/B Thermal Printer

This test requires the General I/O ROM.

### To Test the Printer

1. Make sure that the calculator and printer are properly connected.
2. Turn the printer and calculator ON. The white light above the LINE switch indicates that the printer is ON. If the amber light below the Paper Advance switch lights, you do not have any paper. Start the test with a fresh roll.
3. With the test cartridge in your calculator, press:

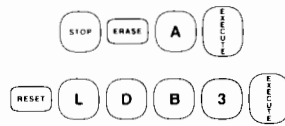

4. The tape should load and the printer should print a message similar to the one below, depending on which ROM(s) are installed in the calculator.

```
PLEASE VERIFY
THE FOLLOWING:
```

```
GEN. I/O ROM IN
EXT. I/O ROM IN
9862A ROM IN
9872A ROM OUT
```

This information will vary depending on ROM(s) that are installed. Other ROM(s) such as Matrix, String, and Systems Programming are not included in listing.

After the ROM verify printout, the display should return with:

ENTER MODEL # TO BE TESTED...

press

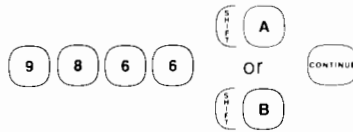

5. When the display returns with:

ENTER SELECT CODE...

enter the select code and press . To specify the factory set select code just press .

6. When the display returns with:

ENTER # OF TIMES TO RUN TEST...

enter the number of times you want the test to run and press .

7. The printout should appear as shown for the appropriate model (see next page).
8. Compare the printout with the sample shown. If the printout differs from the sample, carefully repeat the entire procedure. Should the printout still fail to duplicate the sample, carefully compare each line of the sample with the finished printout. Note any characters which are missing or incompletely printed. If the same errors are repeated line-after-line in your printout, the printer is probably defective.





## 9869A Hopper Card Reader

This test requires the General I/O ROM.

### To Test the Card Reader

1. Make sure that the calculator and card reader are properly connected.
2. Turn the calculator and the card reader ON.
3. With the test cartridge in your calculator, press:

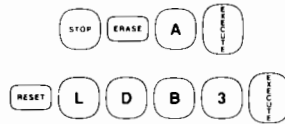

4. The tape should load and the printer should print a message similar to the one below, depending on which ROM(s) are installed in the calculator.

```
PLEASE VERIFY
THE FOLLOWING:
GEN. I/O ROM IN
EXT. I/O ROM IN
9862A ROM IN
9872A ROM OUT
```

This information will vary depending on ROM(s) that are installed. Other ROM(s) such as Matrix, String, and Systems Programming are not included in listing.

After the ROM verify printout, the display should return with:

ENTER MODEL # TO BE TESTED,...

press

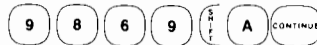



5. When the display returns with:

ENTER SELECT CODE. . .

enter the select code and press . To specify the factory set select code just press .

6. When the display returns with:

CARD DECK # =

enter the test deck number (1, 2, 3, or 4) and then press .

The test deck number to be used depends on the Card Selector switch position. This switch is located on the back panel of the card reader.

Switch position	Use test deck Number
80 Column no. clock	1
40 Column no. clock	2
Clock on Data	3
Clock after Data	4

Depending on the options your card reader has, not all of these positions may be available.

If 0 is entered, instead of a test deck number, the card reader test will be terminated.

7. When the display returns with:

LOAD CARDS, SET SWITCH, PRESS CONT

ensure the Card Selector switch is set as required, load the test card, and press .

38 Peripheral Tests

8. The calculator will read 18 cards while displaying the following test titles:

DEMAND-NORMAL TEST

3 seconds

DEMAND-IMAGE TEST

3 seconds

CONTINUOUS-NORMAL TEST

3 seconds

CONTINUOUS-IMAGE TEST

3 seconds

9. The display should return with:

9869A TEST PASSED

10. Press  and repeat the procedure, starting at step 6, to test the other positions of the Card Selector switch using the appropriate test cards.
11. If the card reader or computer fail to respond as indicated repeat the procedure carefully. If there are still failures contact the nearest HP Sales and Service Office; locations are listed in the back of the 9825 Operating and Programming Reference.

## 9871A Impact Printer

This test requires the General I/O ROM.

### To Test the Printer

1. Make sure that the calculator and printer are properly connected .
2. Switch the calculator and the printer ON.
3. Load the printer with a sheet of 8 1/2" × 14" paper (insert the long edge first).

---

#### NOTE

If your 9871A Printer is equipped with option 98021A Form Feed Accessory, it must be removed prior to running this test. (See 9871A Printer Operating Manual P/N 09871-90000).

---

4. With the test cartridge in your calculator, press:

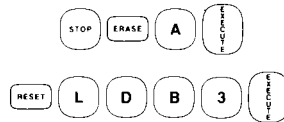

5. The tape should load and the printer should print a message similar to the one below, depending on which ROM(s) are installed in the calculator.

PLEASE VERIFY  
THE FOLLOWING:

```

GEN. I/O ROM IN
EXT. I/O ROM IN
9862A   ROM IN
9872A   ROM OUT
  
```

This information will vary depending on ROM(s) that are installed. Other ROM(s) such as Matrix, String, and Systems Programming are not included in listing.

40 Peripheral Tests

After the ROM verify printout, the display should return with:

ENTER MODEL # TO BE TESTED...

press

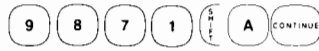

6. When the display returns with:

ENTER SELECT CODE...

enter the select code and press . To specify the factory set select code just press .

7. When the display returns with:

ENTER # OF TIMES TO RUN TEST...

press .



## 9872A Plotter Dynamic Test

This test requires the General I/O ROM and the 9872A Plotter ROM. The 9862A ROM must NOT be installed.

1. Assure that calculator power is turned OFF.
2. Install the General I/O ROM and the 9872A Plotter ROM and connect the interface to the plotter and the calculator. Remove the 9862A Plotter ROM if it is installed.
3. Turn calculator and plotter power ON.
4. With the test cartridge in your calculator, press:

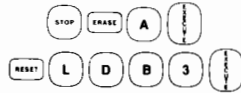

5. The tape should load and the printer should print a message similar to the one below, depending on which ROM(s) are installed in the calculator.

```
PLEASE VERIFY
THE FOLLOWING:
```

```
GEN. I/O ROM IN
EXT. I/O ROM IN
9862A ROM OUT
9872A ROM IN
```

This information will vary depending on ROM(s) that are installed. Other ROM(s) such as Matrix, String, and Systems Programming are not included in the listing.

After the ROM verify printout, the display should return with:

```
ENTER MODEL # TO BE TESTED...
```

press: (9) (8) (7) (2) (C) (A) (CONTINUE)

6. When the display returns with:

```
ENTER SELECT CODE...
```

Enter the select code of the interface followed by the plotter Bus Address. For example, if the interface select code is 7 and the plotter Bus Address is 05.

press:

7. When the display returns with:

ENTER # OF TIMES TO RUN TEST...

enter the number of times you wish to run and test and press: . Each test will take approximately 6 minutes.

8. When the display returns with:

LOAD PAPER & THEN PRESS CONTINUE

assure plotter paper is properly loaded (see pages 3 and 4 of the 9825A/9872A Plotter Programming Manual (P/N 09825-90026) and then press: .

9. The plotter will then produce a 4-color plot similar to the one shown.
10. When the plot is completed the calculator will print `9872A PLOT COMPLETE`
11. To check the plotter digitizing capability re-run the beginning of the plotter test (steps 1 to 6). When display returns with:

ENTER # OF TIMES TO RUN TEST...

enter a negative number (-10 for example).

12. The calculator will print `9872A DIGITIZE`
13. Move the pen on the plotter using the front panel plotter controls and press the plotter  key.

The X, and Y co-ordinate of the pen and the pen up (0) or pen down (1) condition will be displayed. Moving the X and Y position of the pen and pressing  will cause the display on the calculator to change. When the number of points entered is equal to the minus number entered in step 11 the calculator will print `DIGIT MODE COMPLETE`

14. If the plotter fails to reproduce the sample plot, verify that the paper is properly loaded and carefully repeat the test procedure. If the sample plot still cannot be duplicated contact the nearest HP Sales and Service Office; office locations are listed at the back of the 9825 Operating and Programming Reference.

**NOTE**

Four color pens must be installed in the plotter  
in order to duplicate the four color plot.

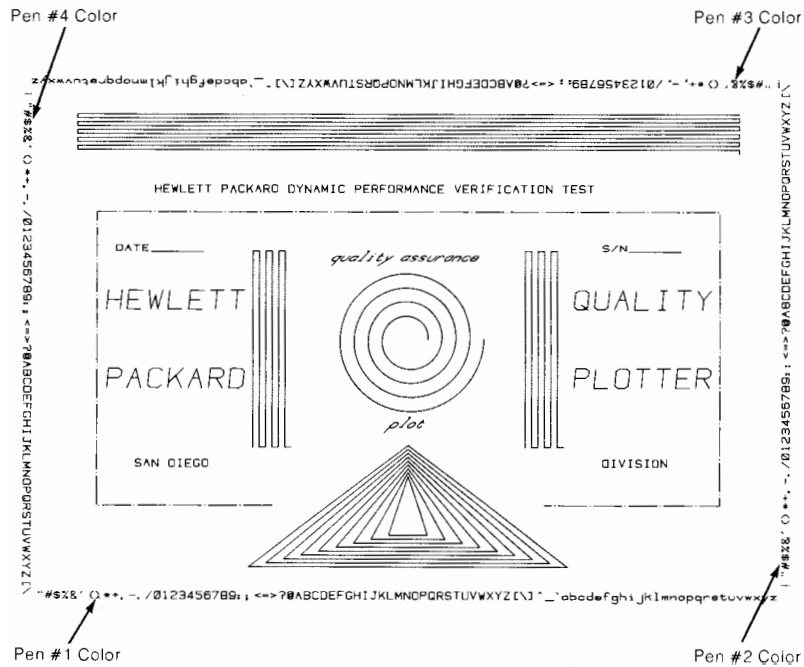



## 9881A Printer Test

This test requires the General I/O ROM.

1. Assure that calculator and printer are turned OFF.
2. Install the General I/O ROM in the calculator and connect the interface to the calculator and the printer and turn calculator and printer power ON.
3. With the test cartridge in your calculator press:

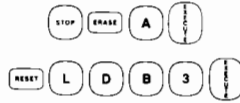

4. The tape should load and the printer should print a message similar to the one below, depending on which ROM(s) are installed in the calculator.

```
PLEASE VERIFY
THE FOLLOWING:
```

```
GEN. I/O ROM IN
EXT. I/O ROM IN
9862A ROM IN
9872A ROM OUT
```

This information will vary depending on ROM(s) that are installed. Other ROM(s) such as Matrix, String, and Systems Programming are not included in listing.

After the ROM verify printout, the display should return with:

```
ENTER MODEL # TO BE TESTED...
```

press: 9 8 8 1 (↑) (A) (CONTINUE)

5. When the display returns with:

```
ENTER SELECT CODE...
```

Enter the select code and press: (CONTINUE)

## 46 Peripheral Tests

6. At this point you can select which tests you want to run. If you wish to run all the tests, press:  1  CONTINUE.

If you wish to run only specific tests, press:  0  CONTINUE.

7. All questions displayed from this point on can be answered by pressing  1  CONTINUE for yes and  0  CONTINUE for no. If you wish to perform specific tests, key in 0 for each test you do not want and 1 for each test you do want.

Here is a list of the six printer tests.

The tests appear in the following order:

1. Dot Matrix
2. Character Set
3. Vertical Format
4. Paper Slew
5. Triangular
6. Ripple

---

### NOTE

When the last test you requested is performed (or when you request no test), the printer will print: **TEST COMPLETE**

---

## Dot Matrix Test

The dot matrix test consists of up to four characters printed across the page a specified number of times. It is the only test you can run more than one time, by answering the first question displayed:

Entire dot matrix test?

Enter 1 for yes and 0 for no. For an initial test, the entire dot matrix test should be performed. Key in  1  CONTINUE.

### Entire Test Procedure

The next question displayed will be:

How many lines of each?

Key in the number of lines of "H", "I", "#", or "." characters you want printed. (For an initial test, 30 lines of each character is advisable.) Entering zero instead of a number at this point will exit the dot matrix test portion of the program and begin the procedure for the next test.

The printer will immediately begin printing each of the four characters mentioned above across the page the specified number of lines.

After these lines have been printed, the procedure for the next test (i.e., Character Set, Vertical Format, etc.) will be performed automatically.

### Partial Test Procedure

The next question displayed will be:

How many lines of each?

Key in the number of lines of "H", "I", "#", or "." characters you want printed. Entering zero instead of a number at this point will exit the dot matrix test portion of the program and begin the procedure for the next test.

The display will now ask whether you want to print any of the following characters, in the order HI#..

Answer each question, with a 1 for yes and a 0 for no, as it appears on the display.

After the printer prints the characters you requested the specified number of times, the display will again ask:

Entire dot matrix test?

Enter 1 for yes or 0 for no. If you enter 1, follow the "Entire test procedure", on the previous page. If you enter 0, follow the "Partial test procedure", from the top of this page.

Compare your printout to the example on the following page. Be sure all characters are aligned and all dots in each character are printed. Alignment should be both vertical and horizontal. Also, be sure the print intensity is uniform.



## Character Set Test

The printer will print one line each of every letter in the alphabet.

Compare your printout to the example on this page. Be sure all characters are printed in each row and in each column, and that all the dots in each character have been printed.

● CHARACTER SET TEST  
● AA  
● BB  
● CC  
● DDD  
● EEE  
● FF  
● GGG  
● HHH  
● III  
● JJJ  
● KKK  
● LL  
● MMM  
● NNN  
● OO  
● PPP  
● QQ  
● RR  
● SSS  
● TTT  
● UU  
● VVV  
● WWWWUUU  
● XXXXXX XXXXXX XXXXXX XXXXXX XXXXXX XXXXXX XXXXXX XXXXXX  
● YY  
● ZZZ

## Vertical Format Test

The printer will print TOP OF FORM on the first line of two pages and BOTTOM OF FORM on the last line of both pages. SINGLE SPACE, DOUBLE SPACE, TRIPLE SPACE, NEXT QUARTER PAGE, NEXT HALF PAGE, NEXT SIXTH PAGE will be printed at appropriate intervals, two per message.

Compare your printout to the example on this page. Be sure all messages are printed in the correct position.

●		●		●	
	SINGLE SPACE		NEXT SIXTH PAGE		NEXT HALF PAGE
●	SINGLE SPACE	●		●	
	SINGLE SPACE				
●	SINGLE SPACE	●		●	
	SINGLE SPACE				
●	SINGLE SPACE	●		●	
	SINGLE SPACE				
●	SINGLE SPACE	●		●	
	SINGLE SPACE		NEXT SIXTH PAGE	●	
●	SINGLE SPACE	●		●	
	SINGLE SPACE				
●	SINGLE SPACE	●		●	
	SINGLE SPACE				
●	SINGLE SPACE	●		●	
	SINGLE SPACE				
●		●		●	
	DOUBLE SPACE				
●	DOUBLE SPACE	●	NEXT SIXTH PAGE	●	
	DOUBLE SPACE				
●	DOUBLE SPACE	●		●	
	DOUBLE SPACE		NEXT QUARTER PAGE	●	
●	DOUBLE SPACE	●		●	
	DOUBLE SPACE				
●		●		●	NEXT HALF PAGE
●	TRIPLE SPACE	●		●	
	TRIPLE SPACE				
●	TRIPLE SPACE	●		●	
	TRIPLE SPACE		NEXT QUARTER PAGE		
●	TRIPLE SPACE	●		●	
	TRIPLE SPACE				

## Paper Slew Test

The printer will print PAPER SLEW in increasing intervals on the page.

Compare your printout to the example on this page. Be sure all messages are printed in the correct position.

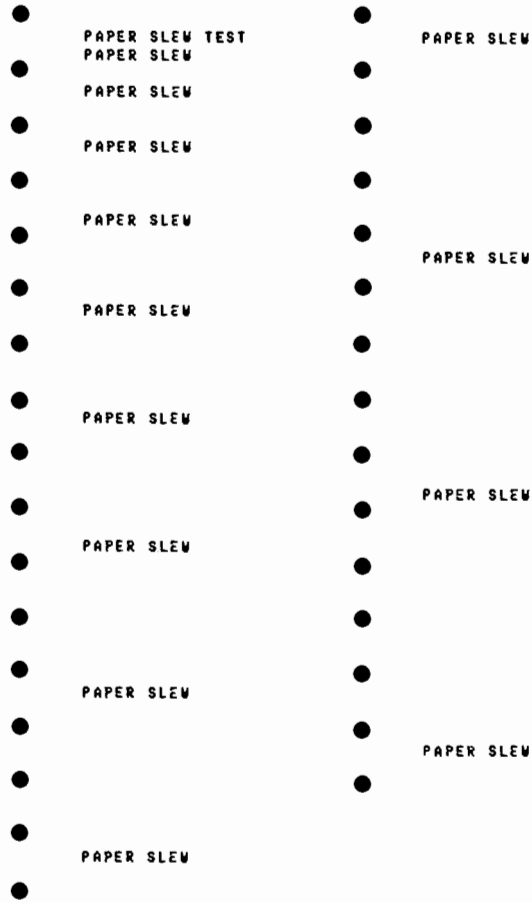





## Ripple Test

All characters will be printed across the page, shifting one column for each of the 132-line printout.

The ripple test is the most complex one of this procedure; it verifies the operation of your printer internally as well as externally.

Compare your printout to the example on the following page. Be sure each character is represented on each line and each column.

---

### NOTE

If your 9881A Line Printer is not equipped with Option 001, only upper case characters will be printed in the "Ripple Test" section.

---

Following the ripple test, the calculator will print:

TEST COMPLETE

If the printer fails to reproduce the sample print pages as shown, carefully repeat the test procedure. If sample prints still cannot be duplicated, contact the nearest HP Sales and Service Office; office locations are listed at the back of the 9825 Operating and Programming Reference.



## 9883A Paper Tape Photo Reader

This test requires the General I/O ROM.

### To Test the Tape Reader

1. Make sure that the calculator and tape reader are properly connected.
2. Switch the calculator and tape reader ON.
3. Load the diagnostic tape (09883-90030) supplied with the tape reader and then press READ on the front of the tape reader.
4. With the test cartridge in your calculator, press:

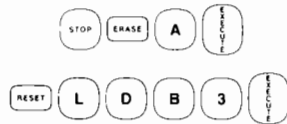

5. The tape should load and the printer should print a message similar to the one below, depending on which ROM(s) are installed in the calculator.

```
PLEASE VERIFY
THE FOLLOWING:
```

```
GEN. I/O ROM IN
EXT. I/O ROM IN
9862A ROM IN
9872A ROM OUT
```

This information will vary depending on ROM(s) that are installed. Other ROM(s) such as Matrix, String, and Systems Programming are not included in listing.

After the ROM verify printout, the display should return with:

```
ENTER MODEL # TO BE TESTED...
```

press

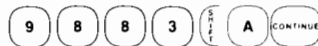

6. When the display returns with:

ENTER SELECT CODE...

enter the select code and press . To specify the factory set select code just press .

7. When the display returns with:

ENTER # OF TIMES TO RUN TEST...

press .

8. When the display returns with:

LOAD TAPE, PRESS CONTINUE

ensure that the punched tape is loaded in the tape reader, and then press .

9. The tape reader should read the entire tape, the calculator will print the errors if they occur.
10. If no errors are printed the tape reader is operating properly.
11. If errors are printed, carefully repeat the procedure. If there are still errors contact your nearest HP Sales and Service Office; office locations are listed at the back of the 9825 Operating and Programming Reference.

## 9884A Paper Tape Punch

This test requires the General I/O ROM.

### To Test the Tape Punch

1. Make sure that the calculator and punch are properly connected.
2. Turn the calculator and the punch ON.
3. Ensure that the punch is loaded with paper tape.
4. Press the FEED HOLES switch on the punch, the following holes should be punched.

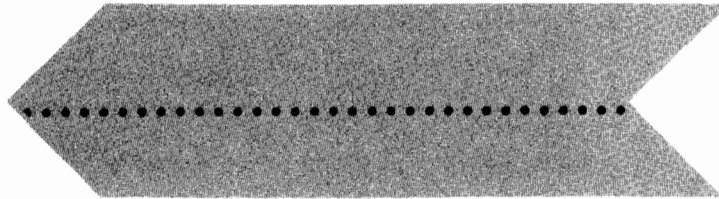

5. Press the CODE HOLES switch on the punch, the following holes should be punched.

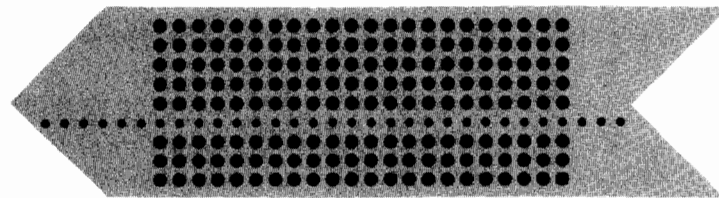

6. With the test cartridge in your calculator, press:

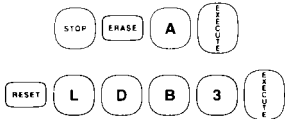

7. The tape should load and the printer should print a message similar to the one below, depending on which ROM(s) are installed in the calculator.

PLEASE VERIFY	This information will vary depending on
THE FOLLOWING:	ROM(s) that are installed. Other ROM(s)
	such as Matrix, String, and Systems Prog-
GEN. I/O ROM IN	ramming are not included in listing.
EXT. I/O ROM IN	
9862A ROM IN	
9872A ROM OUT	

After the ROM verify printout, the display should return with:

ENTER MODEL # TO BE TESTED...

press:

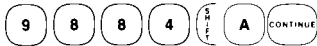

8. When the display returns with:

ENTER SELECT CODE...

enter the select code and press CONTINUE. To specify the factory set select code just press CONTINUE.

60 Peripheral Tests

9. When the display returns with:

ENTER # OF TIMES TO RUN TEST...

enter the number of times you want the test to run and press .

10. The resulting punched tape should be the same as example shown below.

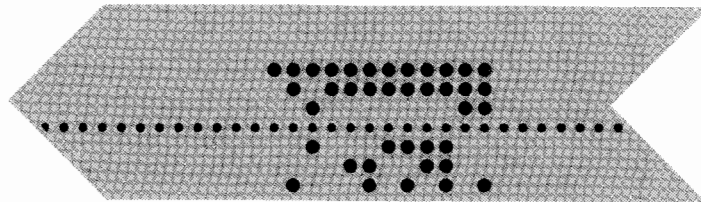

11. If the punched tape is the same, the punch is operating properly.
12. If there are missing holes or if there are extra punched holes, carefully repeat the procedure. If there are still missing or extra holes contact the nearest HP Sales and Service Office; office locations are listed at the back of the 9825 Operating and Programming Reference.



## 98032A 16-Bit Interface

This test requires the General I/O ROM.

### To Test the Interface

1. Remove the Peripheral Configuration Assembly and install the Test Connector (P/N 98241-67932).

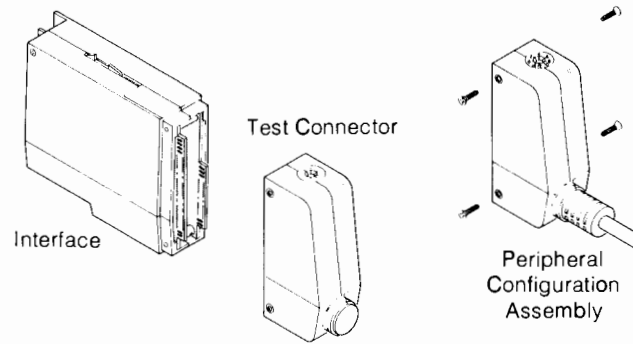

2. Turn the calculator OFF.
3. Plug the interface into the back of the calculator and turn the calculator ON.
4. With the test cartridge in your calculator, press:

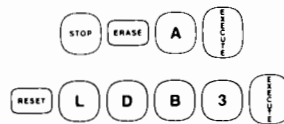

5. The tape should load and the printer should print a message similar to the one below, depending on which ROM(s) are installed in the calculator.

PLEASE VERIFY  
THE FOLLOWING:

GEN. I/O ROM IN  
EXT. I/O ROM IN  
9862A ROM IN  
9872A ROM OUT

This information will vary depending on ROM(s) that are installed. Other ROM(s) such as Matrix, String, and Systems Programming are not included in listing.

After the ROM verify printout, the display should return with:

ENTER MODEL # TO BE TESTED...

press

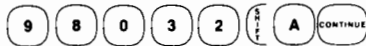

6. When the display returns with:

ENTER SELECT CODE...

enter the select code and press **CONTINUE**. To specify the factory set select code just press **CONTINUE**.

7. When the display returns with:

ENTER # OF TIMES TO RUN TEST...

enter the number of times you want the test to run and press **CONTINUE**.

8. The following displays should be seen while the test is in progress.

```
Doing 98032 DATA PATTERNS TEST
```

60 seconds

```
Doing I/O line TEST
```

15 seconds

```
Doing EXTENDED CTRL and STATUS
```

30 seconds

```
Test of 98032 COMPLETE!
```

2 seconds

During the test the calculator will beep periodically to indicate that the test is still in progress. The printer will print any errors that occur during the test.

9. If no errors are printed the interface is operating properly.
10. If errors are printed, carefully repeat the procedure. If there are still errors, contact the nearest HP Sales and Service Office; office locations are listed at the back of the 9825 Operating and Programming Reference.

## 98033A BCD Interface

This test requires the General I/O ROM.

### To Test the Interface

1. Remove the rear housing and install the Test Connector (P/N 98241-67933) and set all of the configuration switches to OFF (refer to the 98033A BCD Interface Installation and Service Manual).

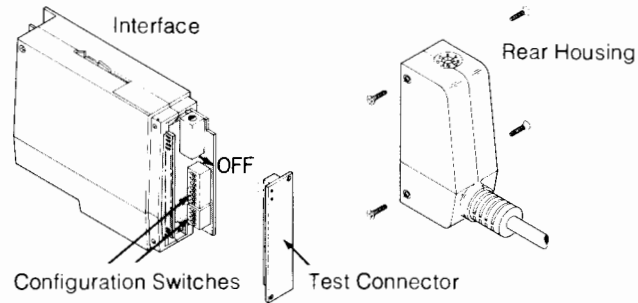

2. Turn the calculator OFF.
3. Plug the interface into the back of the calculator and turn the calculator ON.
4. With the test cartridge in your calculator, press:

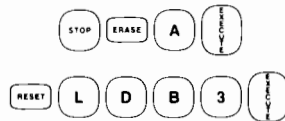

5. The tape should load and the printer should print a message similar to the one below, depending on which ROM(s) are installed in the calculator.

PLEASE VERIFY  
THE FOLLOWING:

```
GEN. I/O ROM IN
EXT. I/O ROM IN
9862A ROM IN
9872A ROM OUT
```

This information will vary depending on ROM(s) that are installed. Other ROM(s) such as Matrix, String, and Systems Programming are not included in listing.

After the ROM verify printout, the display should return with:

ENTER MODEL # TO BE TESTED...

press

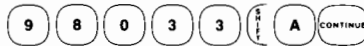

6. When the display returns with:

ENTER SELECT CODE...

enter the select code and press **CONTINUE**. To specify the factory set select code just press **CONTINUE**.

7. When the display returns with:

ENTER # OF TIMES TO RUN TEST...

enter the number of times you want the test to run and press **CONTINUE**.

## 66 Peripheral Tests

8. The following display should be seen while the test is in progress.



```
98033A BCD Interface Test
```

70 seconds

During the test the calculator will beep periodically to indicate that the test is still in progress. The calculator will print any errors that occur during the test.

9. If no errors are printed the interface is operating properly.
10. If errors are printed, carefully repeat the procedure. If there are still errors, contact the nearest HP Sales and Service Office; office locations are listed at the back of the 9825 Operating and Programming Reference.

## 98034A Interface

This test requires the General and the Extended I/O ROM. It also requires two 98034A's: one to be tested and one to perform the tests. The interface to be tested should be set to the factory configuration (refer to the 98034A Installation and Service Manual, P/N 98034-90000). The test interface must be disassembled and reconfigured.

1. Assure that calculator power is OFF.
2. Install the General and Extended I/O ROMs.
3. Following the procedure in the Installation and Service Manual, remove the interface cover on the test interface.
4. Separate case halves as shown in DWG. On 98034-66502 board, change the parallel poll bit from 1 to 2 (see DWG). Note the switch positions before you change them. On the 98034-66501 board, change the talk/listen address switches to ON, ON, OFF, ON, OFF. Set system controller switch to OFF (see DWG). Keep the parallel poll logic switch at the 1 position. Change the select code to 6.
5. Reassemble the test interface. Plug both interfaces into the back of the calculator. Plug HP-IB connectors together and turn calculator power ON.
6. With the test cartridge in your calculator press:

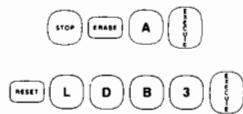

## 68 Peripheral Tests

- The tape should load and the printer should print a message similar to the one below, depending on which ROM(s) are installed in the calculator.

PLEASE VERIFY  
THE FOLLOWING:

GEN. I/O ROM IN  
EXT. I/O ROM IN  
9862A ROM IN  
9872A ROM OUT

This information will vary depending on ROM(s) that are installed. Other ROM(s) such as Matrix, String, and System Programming are not included in listing.

- After the ROM verify printout, the display should return with:

ENTER MODEL # TO BE TESTED...

press:

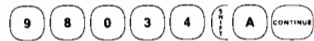

- When the display returns with:

ENTER SELECT CODE...

Enter the select code and press: 

To specify the factory select code, press: 

- When the display returns with:

ENTER # OF TIMES TO RUN TEST...

Enter number of times you want the test to run and press: 

NOTE: One test takes approximately two minutes to complete. Do not run the test more than ten times as this test must access three tape files. Prolonged repetitive tape use is not recommended.



11. The calculator will display which test is in progress and will print:

TEST COMPLETE

when finished. Any errors that occur during the test will be printed.

12. If no errors are printed and the test is completed, the interface is operating properly.
13. When tests have been satisfactorily completed, return the test interface to its factory or user specifications, (refer to the 98034A Installation and Service Manual, P/N 98034-90000) and reassemble the interface.
14. If errors are printed, check to be sure that the configuration switches are set to the factory settings and that the test interface is set as shown in step 4. Carefully repeat the test procedure. If there are still errors, contact the nearest HP Sales and Service Office; office locations are listed at the back of the 9825 Operating and Programming Reference.

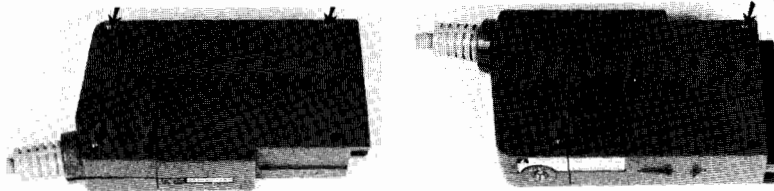

A. Remove only the four screws shown above.

B. Flip the card over and remove these two screws.

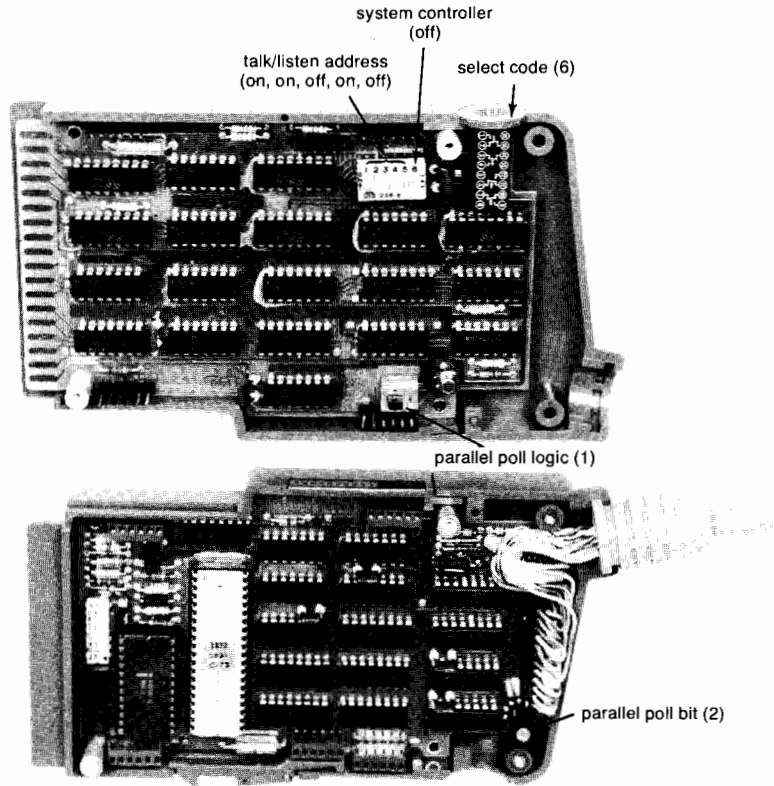

C. Separate the case halves and position them as shown.

## 98035A Real Time Clock

This test requires the General I/O ROM. The test is more extensive with the Extended I/O ROM also installed.

1. Assure that calculator power is turned OFF.
2. Install the selected ROM(s) and remove the Real Time Clock unit. Remove the 4 screws from the rear housing and remove the rear housing (see DWG).
3. Remove the wired connector from the back of the Real Time Clock unit and install the test connector (P/N 9824-67935) in place of the wired connector (see DWG).

NOTE: If your 98035A has the option cable, carefully remove the connector and install the test connector.

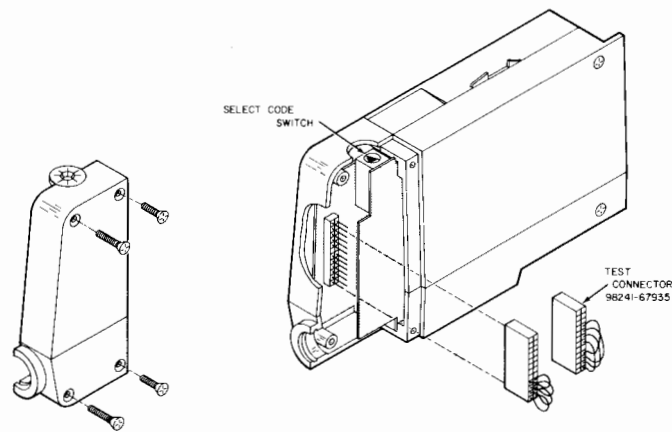

B-533

## 72 Peripheral Tests

4. Plug the Real Time Clock into the back of the calculator and turn the calculator ON.
5. With the test cartridge in your calculator, press:

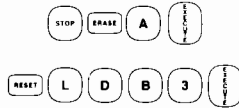

6. The tape should load and the printer should print a message similar to the one below, depending on which ROM(s) are installed in the calculator.

```
PLEASE VERIFY  
THE FOLLOWING:
```

```
GEN. I/O ROM IN  
EXT. I/O ROM IN  
9862A ROM IN  
9872A ROM OUT
```

This information will vary depending on ROM(s) that are installed. Other ROM(s) such as Matrix, String, and System Programming are not included in the listing.

After the ROM verify printout, the display should return with:

```
ENTER MODEL # TO BE TESTED...
```

Press: 9 8 0 3 5 (left arrow) A CONTINUE

7. When the display returns with:

```
ENTER SELECT CODE...
```

enter the select code (located on upper rear of clock unit) and press CONTINUE.  
To specify the factory set select code just press CONTINUE.

8. When the display returns with:

```
ENTER # OF TIMES TO RUN TEST...
```

enter the number of times that you want to run the test and press CONTINUE.

NOTE: One test pass requires approximately 3 minutes to complete.

9. When the display returns with:

TIME CHANGE ON CARD OK? (1=Y, 0=N)

press **1** CONTINUE if the time setting may be changed or **0** CONTINUE if you do not wish to change the time setting. NOTE: The test is not as extensive if the time setting is not changed (e.g., clock hardware not tested completely, set and read commands not checked).

10. The calculator will display each test as it is in progress.

TEST COMPLETE

will be printed when finished. Any errors that occur during the test will be printed.

11. If no errors are printed and the test is completed, the Real Time Clock should be operating properly.
12. When the tests have been satisfactorily completed, remove the test connector, reinstall the wired connector, and reassemble the Real Time Clock unit.
13. If errors are printed, carefully repeat the test procedure. If errors still occur, contact the nearest HP Sales and Service Office; office locations are listed at the back of the 9825 Operating and Programming Reference.

## 98036A Serial Interface

This test requires the General I/O ROM. The test is more extensive with the Extended I/O ROM also installed.

1. Assure that calculator power is turned OFF.
2. Install selected ROM(s) and remove Serial Interface unit. Remove 4 screws from the rear housing and remove the rear housing (see DWG).
3. Remove the wired connector from the back of the interface unit and install the test connector (P/N 98241-67936) in place of the wired connector.

---

### NOTE

Assure that test connector pins line up properly with pins on interface (see DWG). Make note of the BAUD rate switch position.

---

4. Set the BAUD rate switch to position 3. This sets the BAUD rate to 2400 (see DWG).
5. Plug the Serial Interface into the back of the calculator and turn calculator ON.
6. With test cartridge in your calculator, press:

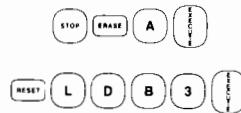

7. The tape should load and the printer should print a message similar to the one below, depending on which ROM(s) are installed in the calculator.

```
PLEASE VERIFY
THE FOLLOWING:

GEN. I/O ROM IN
EXT. I/O ROM IN
9862A ROM IN
9872A ROM OUT
```

This information will vary depending on the ROM(s) that are installed. Other ROM(s) such as Matrix, String, and Systems Programming are not included in listing.

After the ROM verify printout, the display should return with:

ENTER MODEL # TO BE TESTED...

Press:

9 8 0 3 6 (A) CONTINUE

8. When the display returns with:

ENTER SELECT CODE...

enter the select code and press CONTINUE.

9. When the display returns with

ENTER # OF TIMES TO RUN TEST...

enter the number of times you want the test to run and press CONTINUE.

NOTE: One test requires approximately 7½ minutes to complete.

10. When the display returns with

SET BAUD RATE TO 2400 & CONTINUE

verify that the BAUD rate switch on the interface is set to position 3 (see step 4) and press CONTINUE.

## 76 Peripheral Tests

11. The following displays should appear while the test is in progress.

```
DEFAULT MODE # GOOD
```

where # is a number between 1 and 255.

```
MODE # 1, # 2 GOOD
```

where #1 and #2 are numbers between 1 and 255.

```
TESTING R6
```

is displayed if the Extended I/O ROM is installed.

TEST COMPLETE

is printed when finished. The calculator prints any errors that occur during the test.

12. If no errors are printed and the test is completed, the interface is operating properly.
13. When tests have been satisfactorily completed, remove the test connector and reinstall the wired connector, return the BAUD rate switch to its previous position, and reassemble the interface.
14. If errors are printed, check to be sure that the configuration switches are set to the factory settings and carefully repeat the test procedure. If there are still errors, contact the nearest HP Sales and Service Office; office locations are listed at the back of the 9825 Operating and Programming Reference.



98036A Serial Interface

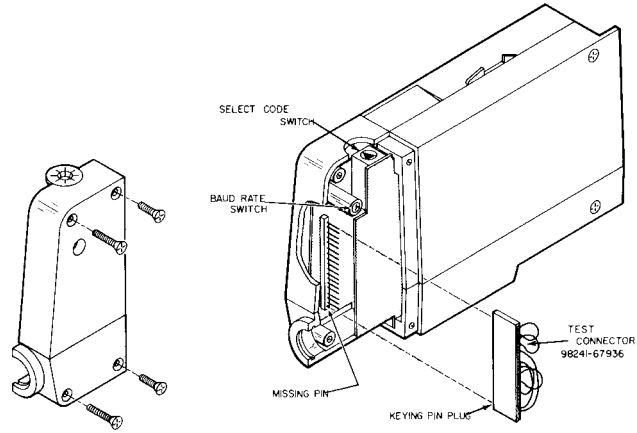

B-502

